

















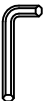

<p><b>#1</b></p>  <p>5/16"x2-1/2" БОЛТ 12 ШТ</p>	<p><b>#2</b></p>  <p>5/16" ШАЙБА 12 ШТ</p>	<p><b>#3</b></p>  <p>РЕГУЛИРОВОЧНАЯ НОЖКА 4 ШТ</p>	<p><b>#4</b></p>  <p>1/4"x3" БОЛТ 8 ШТ</p>
<p><b>#5</b></p>  <p>1/4x2-1/2" БОЛТ 8 ШТ</p>	<p><b>#6</b></p>  <p>1/4" ШАЙБА 24 ШТ</p>	<p><b>#7</b></p>  <p>1/4"x1/2" ГАЙКА 8 ШТ</p>	<p><b>#8</b></p>  <p>БОКОВАЯ ПАНЕЛЬ 2 ШТ</p>
<p><b>#9</b></p>  <p>НОЖКИ 4 ШТ</p>	<p><b>#10</b></p>  <p>ТОРЦЕВАЯ ПАНЕЛЬ 2 ШТ</p>	<p><b>#11</b></p>  <p>ИНСТРУМЕНТ 1 ШТ</p>	<p><b>#12</b></p>  <p>МЕЛОК 2 ШТ</p>
<p><b>#13</b></p>  <p>ЩЕТКА 1 ШТ</p>	<p><b>#14</b></p>  <p>КИИ 2 ШТ</p>	<p><b>#15</b></p>  <p>ТРЕУГОЛЬНИК 1 ШТ</p>	<p><b>#16</b></p>  <p>БИЛЬЯРДНЫЕ ШАРЫ 1 КОМПЛ</p>
<p><b>#17</b></p>  <p>ИНСТРУМЕНТ 1 ШТ</p>	<p><b>#18</b></p>  <p>1/4" ЦИЛИНДРИЧЕСКАЯ ГАЙКА 8 ШТ</p>		

БИЛЬЯРДНЫЙ СТОЛ ДФС DS-VI-P02 Vancouver

ВНИМАНИЕ: ДЛЯ СБОРКИ СТОЛА РЕКОМЕНДУЕТСЯ ДВОЕ ВЗРОСЛЫХ

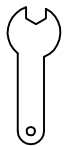
РИС.1

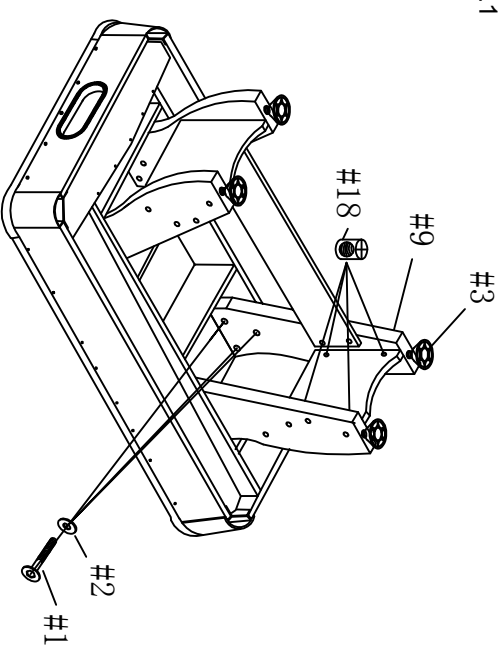

РИС.2

